

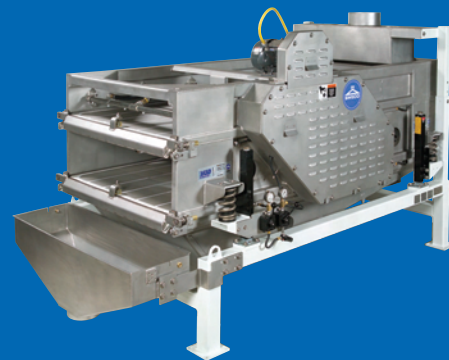

# A history of engineering excellence. A tradition of service.

Sweco's unsurpassed screening experience is backed by the strongest engineering and technical support staff in the industry. Sweco's Rectangular Separator is ideal for a variety of process applications. For installation-specific recommendations on features and accessories, contact your local Sweco application engineer, or call our Technology Center in Florence, Kentucky. Armed with the broadest line of separation and particulate handling equipment, Sweco application engineers solve today's toughest separation problems, while our research and development team anticipates future demands. More than 100 service offices worldwide and an expertly staffed Technology Center are just two of the reasons that companies have been turning to us for solutions — not mere machinery.



Behind each rectangular is the Sweco legacy, synonymous with top quality equipment, innovative design and exacting standards. In fact, this new generation of high-capacity screening equipment comes from the originator of round vibratory machines.



**WWW.SWECO.COM**  
**TECHNICAL LIBRARY**

**Download a PDF of any Sweco product brochure. Just log on to [www.sweco.com](http://www.sweco.com) and click on Technical Library.**

Sweco's mission is to be the world leader in particle-separation and size reduction solutions, and to meet the challenges of an ever-changing world market by seeking innovative new technologies both inside and outside our organization. Sweco will provide responsive, intelligent sales support teams that are as knowledgeable about the needs of our customers as they are about our products, and will engineer and manufacture equipment that provides quality, value and dependability. Sweco will pursue all avenues that may enhance or improve our products and the products of our customers in order to build a solid, lasting relationship with you, our customer.

# Common sense engineering. Uncommon solutions.



- 1 We've engineered the most common elements of downtime OUT of the rectangular to provide nonstop operation. Tough 310 spherical roller bearings support the highest g-force vibrator drive available for your most demanding applications. There are no leaky hydraulics and only bimonthly greasing is required.
- 2 An "off-the-shelf" motor provides reliable power to the vibrator through standard belts and can be replaced in one-half hour. While a "hostile duty" motor suitable for wet environments is included, U.L. listed motors are available for hazardous environments.
- 3 An isolated mount suspension virtually eliminates transmitted vibration. Motion is absorbed by our unique urethane and spring combination, so special support flooring is not needed.
- 4 A rear basket feed inlet with an internal baffle system uniformly distributes flow to the screen bed. This ensures efficient high-volume processing and minimizes wear.
- 5 Every rectangular features an adjustable deck angle. For maximum convenience, an optional hand-crank system allows one operator to change the incline while the machine is in operation. This fine-tuning eliminates the loss of good material due to process changes.

## Air bag systems

Pneumatic seal systems on Sweco's Rectangular Separators utilize a dynamic clamping device where the air bags are constantly under pneumatic pressure to create a positive seal and establish a zero by-pass environment. This simple, convenient system is operator-friendly and allows the user to loosen the screens from outside of the machine.

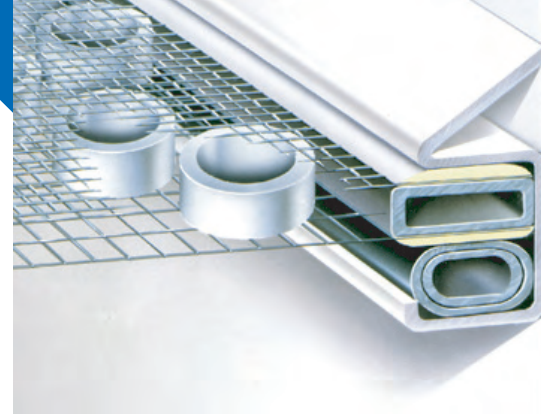

## Hook-style clamping device

Hook-style screens and their clamping devices are an inexpensive way to tension and hold down long, non-tensioned screens typically found in rectangular separators. This manual tensioning and clamping system allows the user to release the tension of the screens from outside the machine, allowing for simple screen removal and making the screens very easy to change.

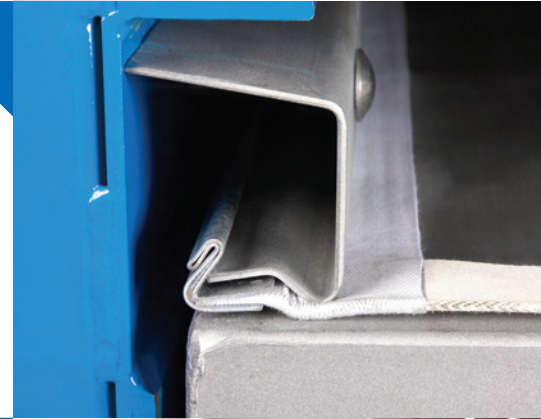

## Wedges

Wedges are an inexpensive and rugged way of holding down a pre-tensioned screen in several models of Sweco Rectangular Separators. This system does not utilize any form of hydraulic or pneumatic utilities similar to other rectangular models. The wedges are simply driven into the wedge area to lock the screens into place.



## Bolt-down systems

Bolt-down systems are available for high temperature applications where air bags are unable to be used due to temperature constraints. These systems should be used for any application over 250° Fahrenheit (121° Celsius).

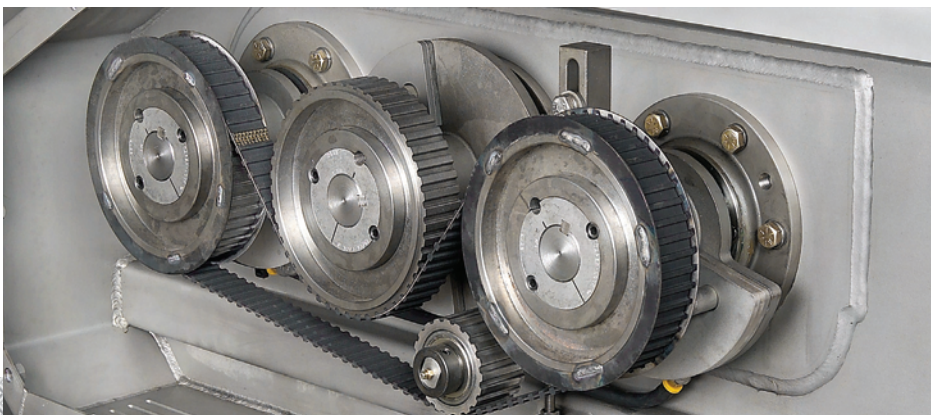
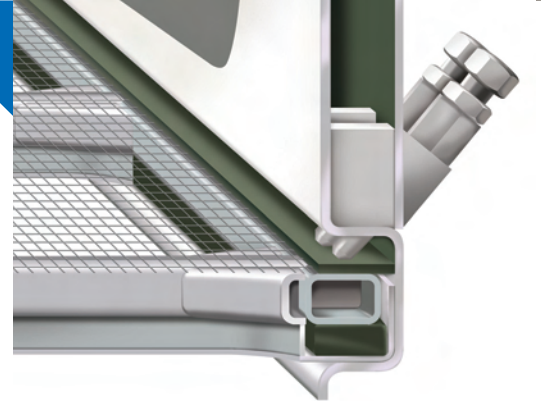

We continually bring new ideas to the high-volume marketplace. Though you've seen numerous other rectangular separators, take a good look at Sweco's Rectangular — and leave the ordinary behind.

# Sweco's broad range of rectangular separators allows greater efficiency and control for any application.



## GYRAMAX

### GyraMax Gyratory Sifter

The Sweco GyraMax Gyratory Sifter was specifically designed for sifting of dry particulate. With its multi-deck (up to five fractions) and high-volume capabilities, the GyraMax is ideal for various applications in many different industries including chemical, mining and minerals, stone, clay and glass, and plastics.

The GyraMax can increase your plant's productivity by reducing the costs associated with routine maintenance and unscheduled repairs. That means fewer production outages and fewer instances of pulling employees away from other duties for unscheduled maintenance. It all adds up to less frustration, greater productivity and lower production costs.

Screen changes are quick and easy, even for multi-deck screeners. With the GyraMax, you can change any screen at any level of the machine from either end without disturbing the other screens. Of course, if you want to change the screen through the top cover, you can do so. But you won't need overhead lifting gear to remove a heavy cover. The dust cover is constructed in sections that can be easily removed.

Screens are tensioned in place and can be easily re-tensioned as needed to return them to peak efficiency as they stretch. Screens are a one-piece hook design that eliminates the need for hundreds of attachment clips. With the GyraMax's easy-access doors, it's even possible to inspect for major problems without disturbing any of the screens or ball trays.



## MM

### Multi-Motion

Sweco engineered the Multi-Motion Rectangular Separator specifically for liquid/solid separation in mind, which makes it ideal for processes that contain any effluent wastewater application. It's true that the MM is an excellent conveyor of solids and its screen changing ability is fast and easy, but its most impressive feature is that of its ability to adapt as solids' characteristics change.

Combining the patented elliptical motion with linear motion technology, the MM is a revolutionary separator that delivers the benefits of two distinct motions. The groundbreaking design of the MM allows operators to use linear motion where heavy, high-volume solids are encountered. In these intervals, separators need to generate high g-forces to effectively move dense solids across the screens.

But as conditions change, the MM can be adjusted "on the fly" without even turning off the machine. With the flip of a switch on the control box, motion is reconfigured from linear to elliptical mode. The solids encounter reduced g-forces and longer screen residence time — resulting in drier solids, longer screen life and reduced operating costs.

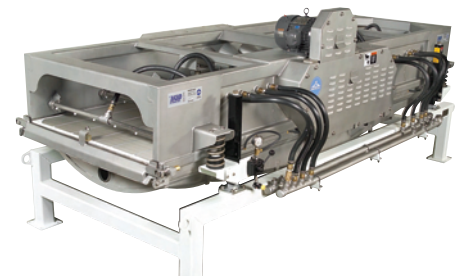

## UM

### Universal Motion

The unique Universal Motion Rectangular Separator is the ultimate in flexibility of changing motions. The UM allows the user to precisely dial in the ideal motion for each application. Until the Sweco UM innovation, completely different machines were necessary for such drastic motion changes. Round, balanced elliptical and linear motions are now simple field adjustments. A patented belt driven, indirect drive system provides all these motions, allowing optimum motion for every unique and sometimes changing application. In addition, the angle of motion, frequency, amplitudes and deck angles can also be adjusted to optimize any process.

Features available on other Sweco Rectangular Separators are also available on the UM. These features include no-tools screen changing, the availability of pre-tensioned screens down to 400 mesh and the availability of several different size machines to accommodate customer capacity. Additionally, our UM models can be equipped with an optional vibrating spray system. Our sprays are designed to help keep the screen apertures clean and wash the oversize product off the screening surfaces.

The UM is ideal for use in many industries, including but not limited to food, chemicals and clay.

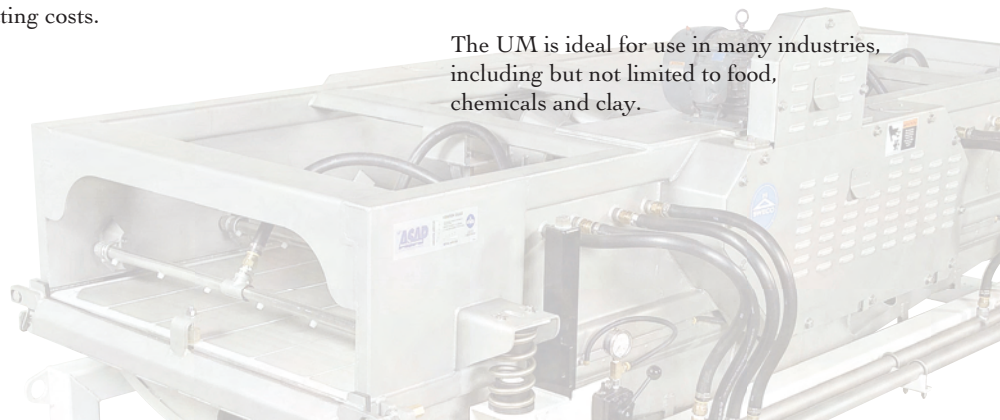

# Custom engineering for specific needs.



## Paper Industry

Sweco offers three sound options for a separation process in the Pulp & Paper Industry — the RM-CIP, UM-CIP and V3-CIP Rectangular Separators. With a paper coating application, processes require the removal of grit and fiber from the coating slurry. The Sweco Paper Coating Rectangular Separators will filter the slurry, reducing the chances of scratches and other defects in your coated paper. Each model is available in a clean-in-place design to virtually eliminate screen blinding and the accumulation of hard coating on internal surfaces.

The RM-CIP utilizes a high-speed circular motion ideal for high throughput screening. Additionally the circular motion places less stress on the screen cloth, which yields longer life for your screens.

The V3-CIP can be tailored to your process to produce either elliptical or linear motion at the flip of a switch. The high g-force produced by the patented drive allows for better conveyance and higher throughputs. The CIP features and modular design make the V3-CIP very easy to clean between production runs, and the machine can be polished to eliminate crevices where material tends to get trapped. The hinged cover makes changing screens easier than any other rectangular separator design.

The UM-CIP can be customized to your process to produce either round, elliptical or linear motion through a series of mechanical adjustments. This model produces more amplitude than any of Sweco's other Rectangular Separators, producing a better conveyance to maximize the machine's throughput. Furthermore, in addition to its three-panel model, the UM-CIP comes in a four-panel design that increases the active screen surface by 33%.

With years of application experience and product knowledge in the Pulp & Paper Industry, Sweco can offer a quality product and technical expertise for your process.







## Round Motion

The gentle screening motion of the Round Motion Rectangular Separator is perfect for both wet and dry processes. The RM's simple two bearing vibratory system, designed to run at 1200-2500 rpm, produces 2-6 g's acceleration. Its effectiveness is maximized when inclined for dry screening or for horizontal wet scalping of slurries with a low percentage of oversized products. Good classification is also consistently achieved as the RM "tumbles and rolls" dry solids.

The standard round motion model is ideal for screening lighter weight materials and can be used throughout the chemical, food, pharmaceutical, plastic and mining industries. Common wet applications include grit removal from fine clay slurries, titanium dioxide and dewatering of plastic pellets. Typical dry applications include the screening of feed meal, plastic resins and fine powders.

Created to meet specific processing requirements, the Sweco RM Rectangular Separator has been tried, tested and proven over nearly two decades of intensive research, development and implementation in hundreds of successful start-ups throughout the process industries.

-  Linear Motion
-  Round Motion
-  Elliptical Motion
-  Sifting Motion



## Dual Motion

One of our latest rectangular separator designs, the V3 was engineered primarily for wet processing of highly viscous material. Its dual motion, high-capacity sanitary design makes it ideal for use in such industries as kaolin clay, food, paper coating and ceramic slip to name just a few.

The V3 offers both elliptical motion and linear motion with just a flip of a control panel switch. Both motions provide benefits, but primarily linear motion offers superior solids conveyance, and elliptical motion generates a much gentler motion and provides excellent screen life.

The V3 has very few moving parts that will require little if any maintenance over the life of the machine. Our interior surfaces have fewer cross-members that make this unit easier to polish for sanitary applications requiring a crevice-free surface. Additionally, the screen basket can be polished to a mirror finish, and a clean-in-place system is available as an option.

The pre-tensioned screens are quick and easy to change. After unclamping and lifting the hinged top cover, any screen can simply be lifted out of the machine regardless of the screen's location. The screens are 100% sealed by Sweco patented pneumatic seals. Unit patented drives produce up to 5.5 g's for extra conveyance and motion generators are warranted for 36 months.

-  Dry Processing
-  Wet Processing



# Custom engineering for specific needs.

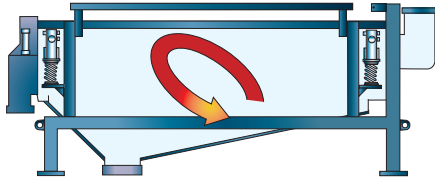

## Elliptical Motion

The Elliptical Motion series uses engineered uni-directional motion. This unique, patented technology combines a strong conveying action with a consistent adjustable ellipse down the full length of the screen deck. This allows you to quickly convey solids while also enhancing screen life.



## Round Motion

The Round Motion series utilizes a high-speed circular vibratory motion, which is best for high throughput screening to remove product impurities. Pure circular motion puts less stress on the screen cloth than any other vibratory motion and therefore yields the longest screen life. Several customers have reported using 325 mesh screens for up to six months.

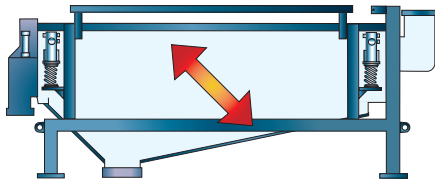

## Linear Motion

The Linear Motion series utilizes a straight-line vibratory motion, which is ideal for conveying solids across the screen surface, especially when large volumes of solids are processed.

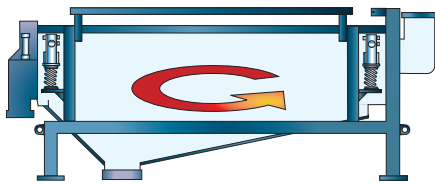

## Sifting Motion

The sifting motion series uses a horizontal gyrotory motion for screening dry materials. The long stroke both spreads material across the full width of the screen and conveys it down the length of the screen. The result is highly efficient screening at exceptionally high processing rates.

## SWECO Rectangular Separator Specifications

Motions										
Screen Type		PreT	PreT	PreT	PreT	Hook	PreT	PreT	PreT	Hook
No. of Screens per Deck		3	2	3	4	2	4	3	4	1
Screen Surface Area per Deck	ft <sup>2</sup> m <sup>2</sup>	30 2.8	18 1.7	30 2.8	40 3.7	24 2.2	26 2.4	30 2.8	40 3.7	20 - 66 1.9 - 6.1
Unit Weight	lbs kg	3000 1361	2000 907	3300 1497	4000 1814	3050 1383	4800 2177	3400 1542	4250 1928	varies
Unit Width	in mm	68 1727	75 1905	75 1905	75 1905	70 1778	64 1626	62 1575	62 1575	varies
Unit Length	in mm	125 3175	86 2184	127 3226	148 3759	95 2413	112 2845	126 3200	162 4115	varies

(PreT is Pre-tensioned)

(Specifications may vary)

# Authentic Sweco Aftermarket Products



## Accessories

Enhance the performance of your rectangular separator by selecting from a variety of options:

For process lines whose specifications change frequently, the Adjust-A-Vibe Motion Controller allows fine-tuning of vibration speed, direction and start/stop cycles. Material flow and patterns can be adjusted to increase throughput or efficiency.

Self cleaning kits and ball boxes assist in keeping screens clean by dislodging particles or fibers that tend to blind the screen and reduce screen area.

Spray bars and traveling spray configurations help to keep screen openings clear. Pressure booster pumps with timed controls for high-pressure clean-in-place systems can also be provided.

Customized covers prevent splashing, minimize dust and keep contamination out of the product stream.

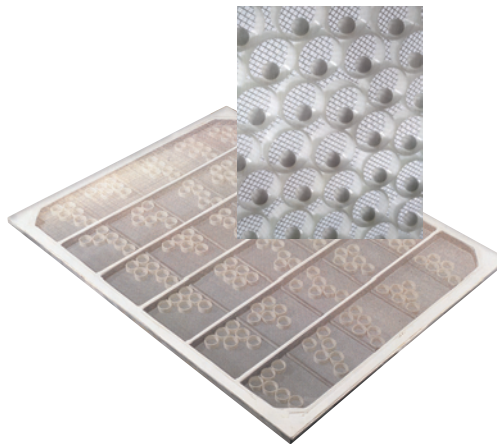

## Advanced Screen Designs

From pre-tensioned rectangular screens to SuperHook hook screens, Sweco can offer a customized screen solution for every application. Rectangular pre-tensioned screens offer ultra-tight mesh mounting in a variety of configurations, including the one-piece cartridge self-cleaning design which provides dynamic anti-blinding for wet and dry materials. SuperHook screens are available for virtually any rectangular or gyratory sifter on the market. Offered in a choice of galvanized or stainless steel hooks, SuperHook screens come in a variety of sizes up to 12' long in a one-piece or two-piece hook design. Mesh choices for both the pre-tensioned and SuperHook screens include 304SS, 316SS, 430SS, nylon or polyester synthetics and Magnum, a patented Sweco design providing improved screen life and solids conveying. Manufactured to exacting standards and backed by unmatched service, Sweco provides the latest technology for your screening needs.

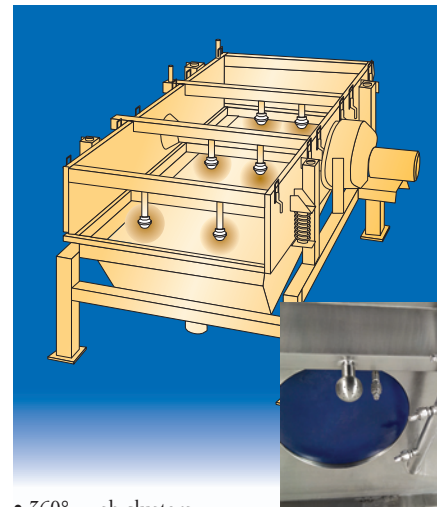

- 360° wash clusters
- Eight-point seal track wash
- Three-point reject chute wash
- Single inlet connection for all nozzles, seal track and reject chute washers
- Five-point reject wash-off spray
- Four-point screen mist spray



Spout connectors provide an efficient means to connect your separator to other equipment. Special configurations are designed to handle the vibratory motion of all Sweco rectangular machines. A wide variety of materials including gum rubber, neoprene, rubber-coated nylon, silicone, polyurethane and viton are available to meet the needs of any process.



We offer screens that meet specifications from these and other industry organizations.



Sweco, Sweco and logo, Motion Generators, TechLube, GyraMax, Adjust-A-Vibe, Supertaut, SuperHook, Magnum, V3 and We Put Technology in Motion are trademarks or registered trademarks of M-I L.L.C.

**my.sweco.com**

**You can now purchase all your aftermarket products online!**

Log in to register or contact Sweco at +1 (800) 80 SWECO